

# Installation

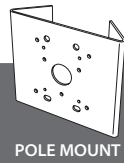

POLE MOUNT

## CONTENTS

1. POLE MOUNT BRACKET	1EA	4. SPRING WASHER	4EA
2. SUS BAND	2EA	5. WASHER	4EA
3. M6 BOLT & NUT	4EA	6. MANUAL	1EA

1. Fix the wanted bracket on the pole mount bracket with 4 ea of M6 BOLT before you install the pole mount bracket. (FIG. 1)

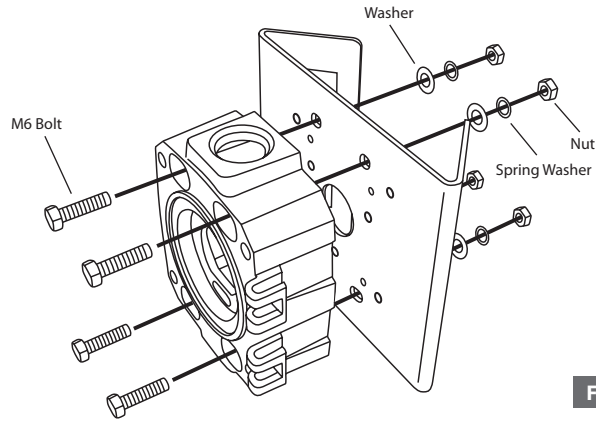

FIG. 1

2. Tie the bracket with SUS BAND tightly. (FIG. 2)

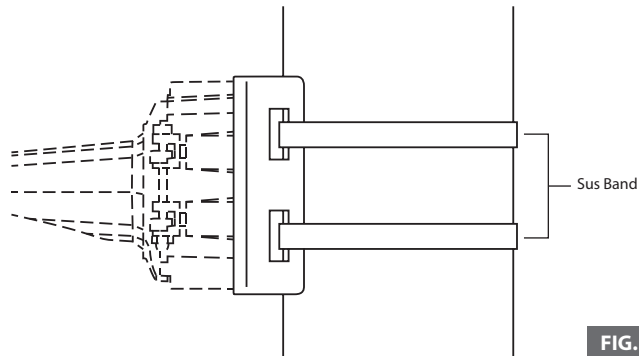
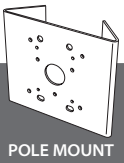

FIG. 2

# Installation



POLE MOUNT

## CONTENTS

1. POLE MOUNT BRACKET	1EA	4. SPRING WASHER	4EA
2. SUS BAND	2EA	5. 3mm L-WRENCH	1EA
3. M4 x 12 BOLT	4EA	6. MANUAL	1EA

1. Fix the wanted bracket on the pole mount bracket with 4 ea of M4 BOLT before you install the pole mount bracket. (FIG. 3)
2. Tie the bracket with SUS BAND tightly. (FIG. 2)

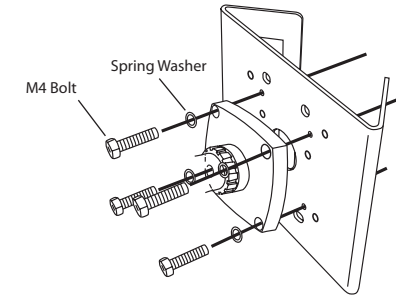

FIG. 3

## CONTENTS

1. POLE MOUNT BRACKET	1EA	4. SPRING WASHER	4EA
2. SUS BAND	2EA	5. 4mm L-WRENCH	1EA
3. M5 x 15 BOLT	4EA	6. MANUAL	1EA

1. Fix the wanted bracket on the pole mount bracket with 3 ea(FIG. 4) or 4 ea(FIG. 5) of M5 BOLT before you install the pole mount bracket.
2. Tie the bracket with SUS BAND tightly. (FIG. 2)

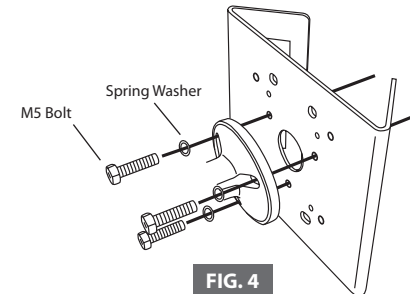

FIG. 4

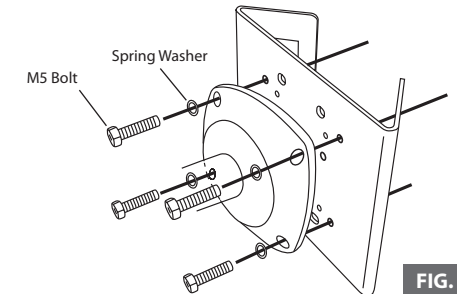

FIG. 5